







ST 010 108 2811



- saillie 167 mm
- bec déverseur fixe
- jet rectangulaire enrichi en air
- hauteur de robinetterie 198 mm
- hauteur jusqu'au mousseur 133 mm
- diamètre de percement du bec 35 mm
- diamètre de percement des robinets latéraux 32 mm
- poignée Ø 60 mm
- débit maxi. 4,5 l/min
- sans plomb
- avec marquage chaud/froid
- Ce produit contribue au respect des exigences des systèmes d'évaluation des bâtiments écologiques, par exemple LEED®, BREEAM®, DGNB

|  |                                   |                    |
|--|-----------------------------------|--------------------|
|  | Chrome                            | ST 010 108 2811-00 |
|  | Platine brossé                    | ST 010 108 2811-06 |
|  | Dark Chrome                       | ST 010 108 2811-19 |
|  | Laiton brossé (Or 23cts)          | ST 010 108 2811-28 |
|  | platine / platine mat             | ST 010 108 2811-36 |
|  | Laiton / Laiton brossé (Or 23cts) | ST 010 108 2811-38 |
|  | Dark Platinum brossé              | ST 010 108 2811-99 |

**Composants individuels de ce set**

Ce set requiert les composants suivants

1x 20 713 811-00



1x 11 283 811-00











ST 010 108 2811



- saillie 167 mm
- bec déverseur fixe
- jet rectangulaire enrichi en air
- hauteur de robinetterie 198 mm
- hauteur jusqu'au mousseur 133 mm
- diamètre de percement du bec 35 mm
- diamètre de percement des robinets latéraux 32 mm
- poignée Ø 60 mm
- débit maxi. 4,5 l/min
- sans plomb
- Ce produit contribue au respect des exigences des systèmes d'évaluation des bâtiments écologiques, par exemple LEED®, BREEAM®, DGNB

ATTENTION : les inserts à poignée doivent être commandés séparément des robinetteries !

|  |                                   |               |
|--|-----------------------------------|---------------|
|  | Chrome                            | 20 713 811-00 |
|  | Platine brossé                    | 20 713 811-06 |
|  | Dark Chrome                       | 20 713 811-19 |
|  | Laiton brossé (Or 23cts)          | 20 713 811-28 |
|  | platine / platine mat             | 20 713 811-36 |
|  | Laiton / Laiton brossé (Or 23cts) | 20 713 811-38 |
|  | Dark Platinum brossé              | 20 713 811-99 |

ST 010 108 2811

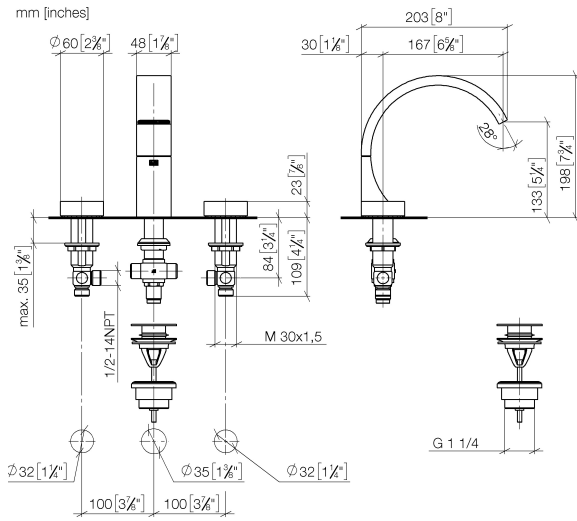

**Diagramme de débit**

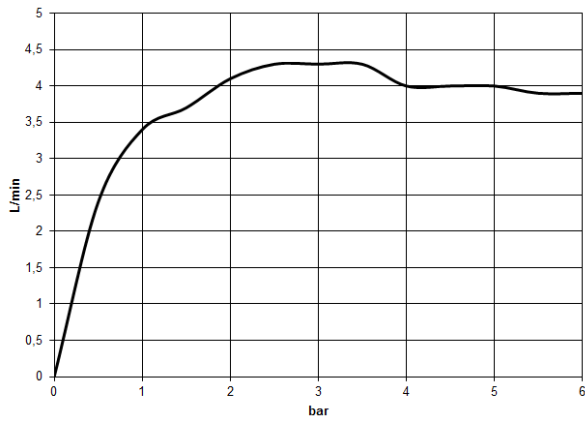

**Certificats**

WRAS\_2111022. LGA\_38118.

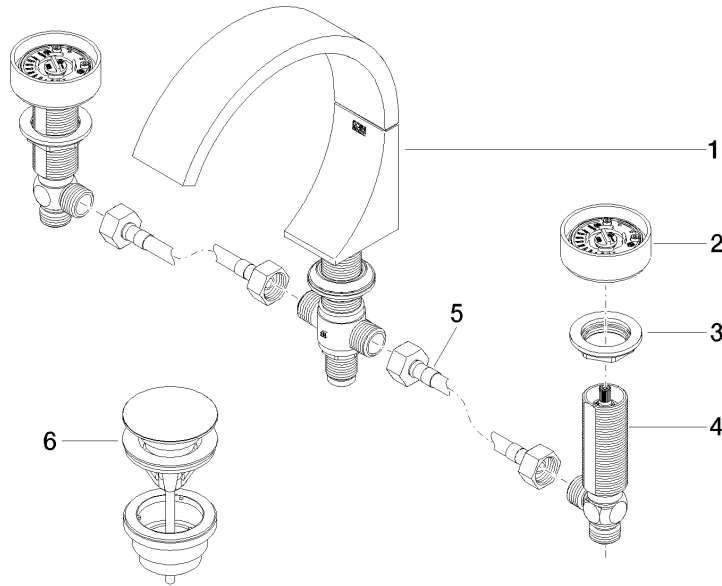

Liste des pièces de rechange

| N° | Article Numéro     | Désignation   | Fréquence de montage | Délai de livraison |
|----|--------------------|---|----------------------|--------------------|
| 1  | 13 717 811-00      | CYO Bec déverseur pour lavabo, montage sur gorge sans garniture d'écoulement - Chrome | 1                    | 10                 |
| 2  | 90 18 40 290 00-00 | poignée   | 2                    | 10                 |
| 3  | 04 30 11 038 67 90 | set de fixation   | 2                    | 2                  |
| 4  | 04 17 11 055 61 90 | partie latérale   | 2                    | 2                  |
| 5  | 04 30 04 096 00 90 | flexible  | 2                    | 2                  |
| 6  | 10 125 970-00      | Garniture d'écoulement avec fermeture à pression 1/4" - Chrome                        | 1                    | 2                  |

ST 010 108 2811



- avec marquage chaud/froid
- pour les mélangeurs de lavabo à trois trous et les mélangeurs de bain à cinq

|  |                             |               |
|--|-----------------------------|---------------|
|  | Chrome                      | 11 283 811-00 |
|  | Platine brossé              | 11 283 811-06 |
|  | Platine                     | 11 283 811-08 |
|  | Laiton (Or 23cts)           | 11 283 811-09 |
|  | Dark Chrome                 | 11 283 811-19 |
|  | Laiton brossé (Or 23cts)    | 11 283 811-28 |
|  | Champagne brossé (Or 22cts) | 11 283 811-46 |
|  | Champagne (Or 22cts)        | 11 283 811-47 |
|  | Dark Platinum brossé        | 11 283 811-99 |







ST 010 108 2811

Les pièces pour les  
autres finitions  
peuvent être  
trouvées ici : Platine  
brossé

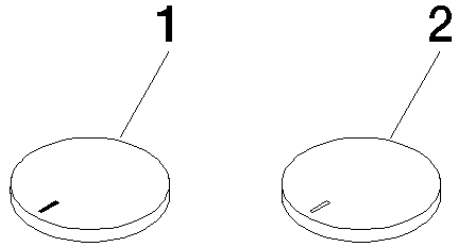

### Liste des pièces de rechange

| N° | Article Numéro | Désignation                          | Fréquence de montage | Délai de livraison |
|----|----------------|--------------------------------------|----------------------|--------------------|
| 1  | 11 183 811-00  | CYO Insert de poignée chaud - Chrome | 1                    | 10                 |
| 2  | 11 184 811-00  | CYO Insert de poignée froid - Chrome | 1                    | 10                 |